

YEARS: 2015-PRESENT

MAKE: LAND ROVER

MODEL: DISCOVERY SPORT

STYLE: SUV

WARNING: NEVER EXCEED YOUR VEHICLE MANUFACTURER'S RECOMMENDED TOWING CAPACITY
 For more information log onto www.curtmfg.com & for helpful towing tips log onto www.hitchinfo.com

WEIGHT CARRYING:
 TRAILER WEIGHT: 4,500 LBS.
 TONGUE WEIGHT: 675 LBS.

PRO INSTALL TIME: 45 MIN.
NOVICE INSTALL TIME: 90 MIN.

IF YOU ARE HESITANT TO UNDERTAKE THIS TASK ON YOUR OWN, CONTACT AN AUTHORIZED CURT INSTALLER FOR ADDITIONAL ASSISTANCE.

INSTALLATION REQUIRES:

RATCHET	SOCKET 10mm 18mm 22mm	TORQUE WRENCH
DIE GRINDER	SOCKET EXTENSION 6"	MASKING TAPE
TAPE MEASURE	SAFETY GLASSES	CUT-OFF WHEEL

INSTALLATION TIPS:

- BEFORE YOU BEGIN INSTALLATION, READ ALL INSTRUCTIONS THOROUGHLY.
- TO EASE INSTALLATION, 2 PEOPLE MAY BE REQUIRED.
- USING PROPER TOOLS WILL GREATLY IMPROVE THE QUALITY OF THE INSTALL AND REDUCE THE TIME REQUIRED.
- NEED HELP OR HAVE SOME QUESTIONS? CALL TECHNICAL SUPPORT AT 800.798.0813

LEVEL OF DIFFICULTY: MODERATE

EASY	MODERATE	CHALLENGING
	UNDERBODY PANEL AND LOWER BUMPER COVER FASCIA	
	UNDERBODY PANEL (AS NEEDED) AND LOWER BUMPER COVER FASCIA	
	NO DRILLING REQUIRED	
	LOWER EXHAUST (3) HANGERS	

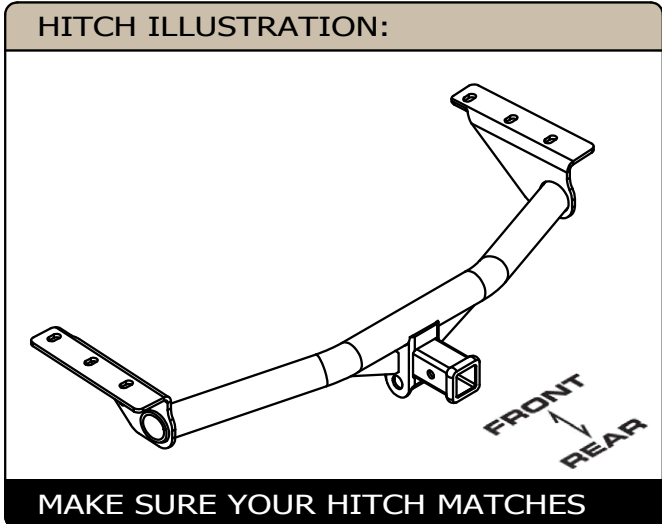
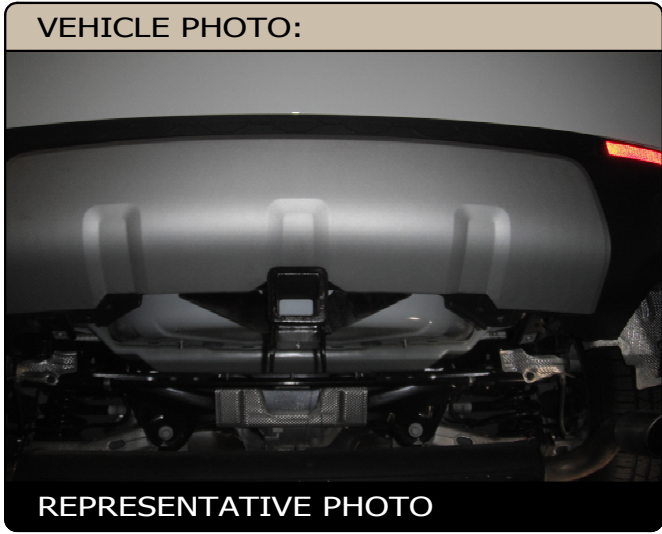

PERIODICALLY CHECK THIS RECEIVER HITCH TO ENSURE ALL FASTENERS ARE TIGHT AND ALL STRUCTURAL COMPONENTS ARE SOUND
 CURT Manufacturing LLC. warrants this product to be free of defects in material and/or workmanship at the time of retail purchase by the original purchaser. If the product is found to be defective, CURT Manufacturing LLC. may repair or replace the product at their option, when the product is returned, prepaid, with proof of purchase. Alteration to, misuse of, or improper installation of this product voids the warranty. CURT Manufacturing LLC.'s liability is limited to repair or replacement of products found to be defective, and specifically excludes liability for incidental or consequential loss or damage.
 For more information log onto www.curtmfg.com
 This product complies with safety specifications and requirements for connecting devices and towing systems of the state of New York, V.E.S.C.Regulation V-5 and SAE J684.

INSTALLATION WALKTHROUGH:

Parts List			
ITEM	QTY	PART NUMBER	DESCRIPTION
1	6	5_8 WASHER	WASHER
2	6	5_8 LOCK WASHER	HELICAL LOCK WASHER
3	6	M14 - 2 x 120 HEX	HEX BOLT

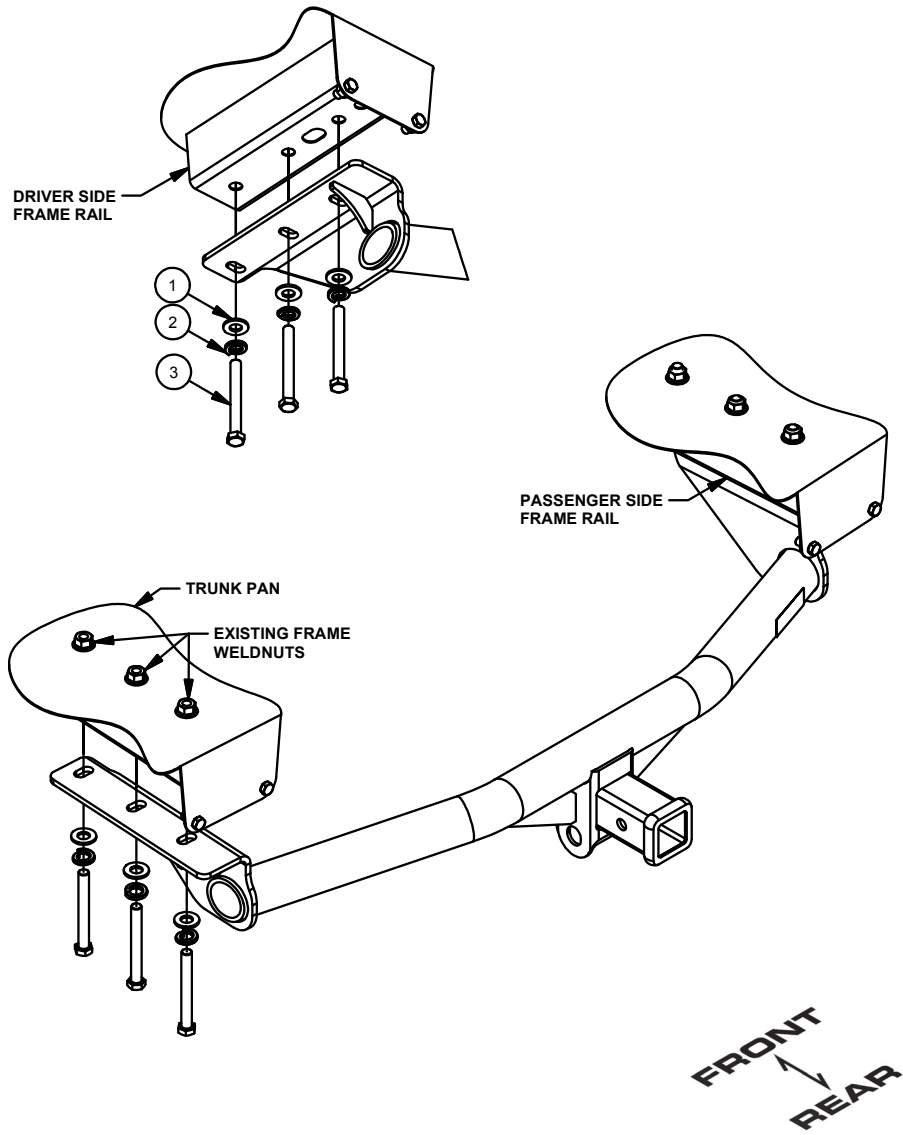

- 1) Remove (1) bolt attaching the rubber exhaust isolator brackets to the frame with a 10mm socket. Lift the rubber isolator brackets off of the frame. Remove (1) rubber exhaust hanger further forward under the vehicle.

NOTE: Support the forward exhaust when removing hangers.

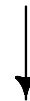

- 2) Remove (8) nuts and (10) bolts using a 10mm socket to remove the plastic underbody panel and lower bumper cover fascia.



INSTALLATION WALKTHROUGH:

- 3) If present, remove the (2) hex flange bolts using an 18mm socket on the passenger side of the frame and return to owner.



- 4) Raise the hitch into position, loosely install (6) supplied hex bolts, lock washers and washers with a 22mm socket as shown.

- 5) Torque all 14mm fasteners to 88 lb-ft.

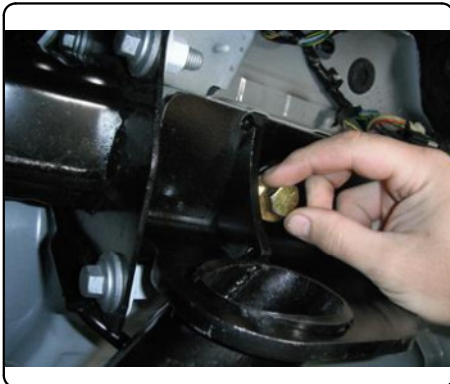

- 6) Trim the plastic underbody panel as needed and reinstall. Reinstall exhaust.

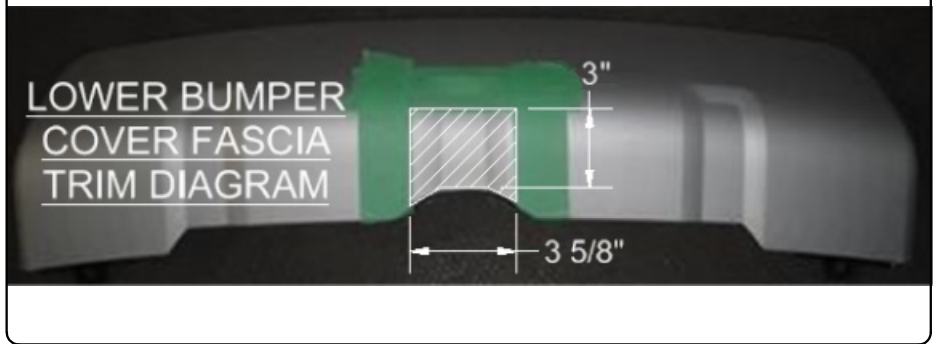

- 7) Trim the lower bumper cover fascia as shown in the diagram above and reinstall.



TOWING SAFETY INFORMATION

Gross Trailer Weight / GTW

The Gross Trailer Weight is the weight of the trailer & cargo. Measure this by putting the fully loaded trailer on a vehicle scale.

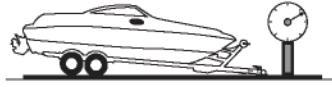

Tongue Weight / TW

The downward force that is exerted on the hitch ball by the coupler. The tongue weight will vary depending on where the load is positioned in relationship to the trailer axle(s). To measure the tongue weight, use either a commercial scale or a bathroom scale with the coupler at towing height. When using a bathroom scale with heavier tongue weights, use the method shown and multiply the scale reading by 3.

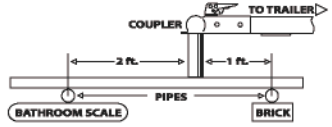

Weight Carrying / WC

The total weight of both the trailer and the cargo inside. Never exceed the weight capacity of your trailer hitch.

Weight Distribution / WD

Used to balance the weight of the cargo between the front and rear wheels throughout the trailer, allowing for better steering, braking, and level riding.



Sway Control

A device used to reduce the lateral movements of the trailer that are caused by the wind. This works in conjunction with a weight distribution hitch. Do not use this on a class 1 or 2 hitch, or with surge brakes.

How Much Can You Safely Tow?

TONGUE WEIGHT lbs	1000	2000	3000	4000	5000	6000	7000	8000	10,000	12,000
Tongue weight should be about 10 to 15 percent of the gross trailer weight.										
CLASS 1										
CLASS 2										
CLASS 3										
CLASS 4										
CLASS 5										
Camper	11'	12'	13'	14'	15'	16'				
lbs	1100	1200	1300	1400	1500	1600				
Vacation	14'	16'	18'	20'	22'	24'	26'	28'	30'	32'
lbs	2100	2400	2700	3000	3300	3600	3900	4200	4500	4800
Vacation	14'	16'	18'	20'	22'	24'	26'	28'	30'	32'
lbs	2800	3200	3600	4000	4400	4800	5200	5600	6000	6400
5th Wheel										

Refer to owner's manual for towing capabilities and limitations.

Ball Mount

The ball mount is placed inside the opening of the receiver hitch which is mounted to the vehicle. Make sure a hitch pin and clip is properly securing the ball mount to the receiver hitch before you begin towing.

- A: Rise. B: Drop. C: Hole Size. D: Length.

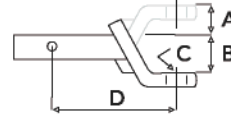

Trailer Ball

The connection from the hitch to the trailer. There are many factors that determine the correct hitch ball:

- Number one is the hitch ball's gross trailer weight rating.
- The mounting platform must be at least 3/8" thick.
- The hole diameter must not be more than 1/16" larger than the threaded shank.
- Every time you tow, check the nut and lock washer to make sure they are fastened securely.
- A: Ball Dia. B: Shank Dia. C: Shank Length. D: Shank Rise.

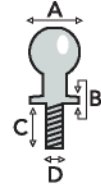

Coupler

The component that is placed over the trailer ball to connect the vehicle to the trailer. Be sure that the coupler size matches the size of the hitch ball and that the coupler handle is securely fastened. To determine what size hitch ball you need for your application you will need to know the size of coupler that is on the trailer. Be sure your coupler is properly adjusted to the ball you are using.

NOTE: For added security the use of safety devices such as Coupler Safety Pins and Locks is strongly recommended.

Safety Chains

Safety chains are a requirement and should be crossed under the tongue of the trailer so that the tongue will not drop to the road if it becomes separated from the hitch. Always leave enough slack so you can turn. Never allow the safety chains to drag on the ground and never attach the chains to the bumper.

Trailer Classification: Safety Chain Breaking Force - Minimum

- Class 1: 2,000 lbs. (8.9 kN)
- Class 2: 3,500 lbs. (15.6 kN)
- Class 3: 5,000 lbs. (22.2 kN)

The strength rating of each length of safety chain or its equivalent and its attachments shall be equal to or exceed in minimum breaking force the GVWR (Gross Vehicle Weight Rating) of the trailer.

Electrical

Trailer lights, Electric Brakes, Break-away systems - Every time you tow, be sure to check that all components are working properly.

Wiring identification by color:



GREEN YELLOW BROWN WHITE RED BLUE PURPLE

13396

LAND ROVER DISCOVERY SPORT

1/14/2019

GROSS LOAD CAPACITY WHEN USED AS A WEIGHT CARRYING HITCH: 4,500 LBS. TRAILER WEIGHT & 675 LBS. TONGUE WEIGHT.



WARNING: * DO NOT EXCEED VEHICLE MANUFACTURER'S RECOMMENDED TOWING CAPACITY *****

FOR MORE INFORMATION LOG ONTO WWW.CURTMFG.COM
 HAVING INSTALLATION QUESTIONS? CALL TECHNICAL SUPPORT AT 1-800-798-0813



Parts List			
ITEM	QTY	PART NUMBER	DESCRIPTION
1	6	5_8 WASHER	WASHER
2	6	5_8 LOCK WASHER	HELICAL LOCK WASHER
3	6	M14 - 2 x 120 HEX	HEX BOLT

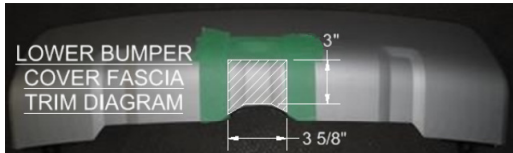
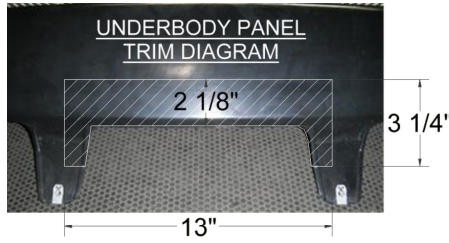

TRIM DIMENSIONS ARE REFERENCE ONLY

WELDNUT CLEANING

To remove debris from weldnuts in frame, spray lubricant or compressed air into hole. For heavy debris, use a small wire brush. (Be careful not to damage threads).

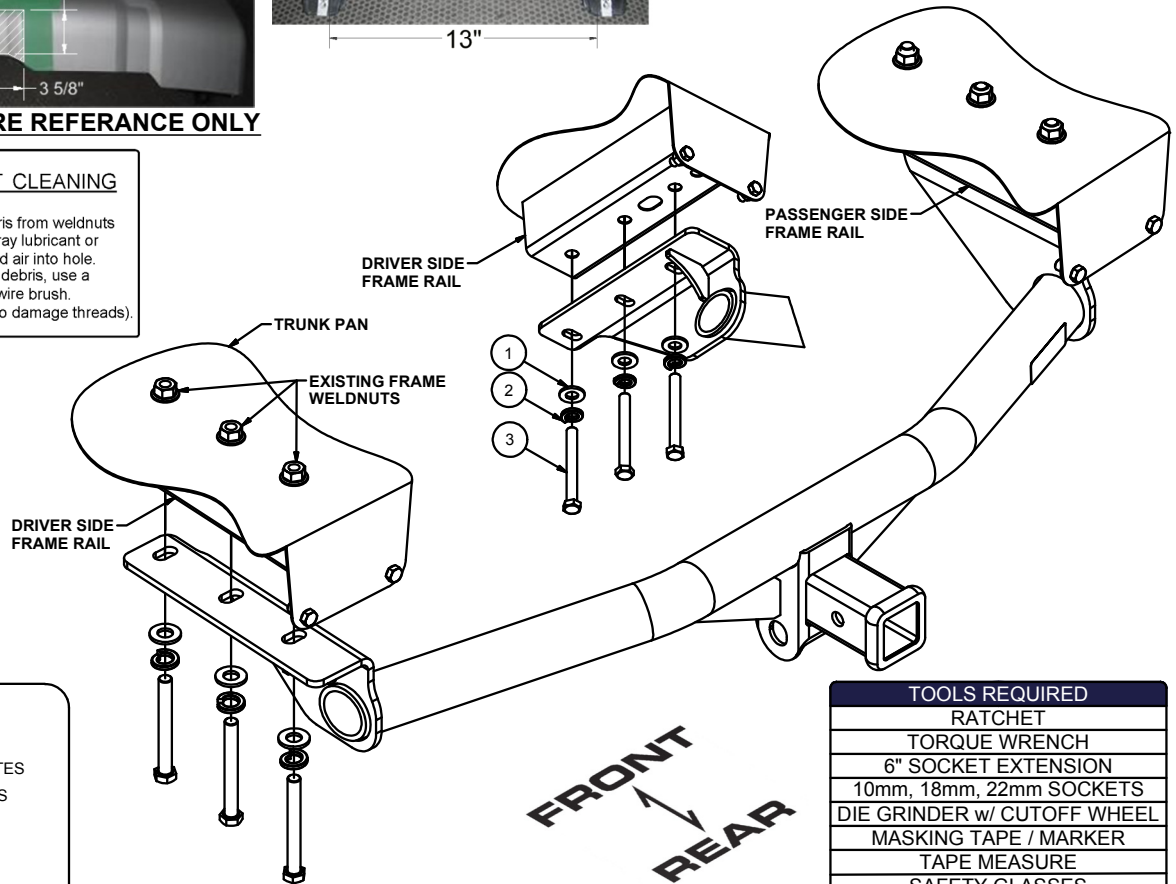

HITCH WEIGHT: 43 LBS.
 INSTALL TIME
 PROFESSIONAL: 45 MINUTES
 NOVICE (DIY): 90 MINUTES
 INSTALL NOTES:
 - LOWER EXHAUST
 - NO DRILLING REQUIRED
 - TRIMMING REQUIRED
 - REMOVE UNDERBODY PANEL

TOOLS REQUIRED
RATCHET
TORQUE WRENCH
6" SOCKET EXTENSION
10mm, 18mm, 22mm SOCKETS
DIE GRINDER w/ CUTOFF WHEEL
MASKING TAPE / MARKER
TAPE MEASURE
SAFETY GLASSES

INSTALLATION STEPS

1) Remove (1) bolt attaching the rubber exhaust isolator brackets to the frame with a 10mm socket. Lift the rubber isolator brackets off of the frame. Remove (1) rubber exhaust hanger further forward under the vehicle.

NOTE: Be sure to support the exhaust when removing hangers.

- Remove (8) nuts and (10) bolts using a 10mm socket to remove the plastic underbody panel and lower bumper cover fascia.
- If present, remove the (2) hex flange bolts using an 18mm socket on the passenger side of the frame and return to owner.
- Raise the hitch into position, loosely install (6) supplied hex bolts, lock washers and washers with a 22mm socket as shown.
- Torque all 14mm fasteners to 88 lb-ft.
- Trim the plastic underbody panel as needed and reinstall. Reinstall exhaust.
- Trim the lower bumper cover fascia as shown in the diagram above and reinstall.

PERIODICALLY CHECK THIS RECEIVER HITCH TO ENSURE THAT ALL FASTENERS ARE TIGHT AND THAT ALL STRUCTURAL COMPONENTS ARE SOUND.



Scan for more information

CURT Manufacturing LLC., warrants this product to be free of defects in material and/or workmanship at the time of retail purchase by the original purchaser. If the product is found to be defective, CURT Manufacturing LLC., may repair or replace the product, at their option, when the product is returned, prepaid, with proof of purchase. Alteration to, misuse of, or improper installation of this product voids the warranty. CURT Manufacturing LLC.'s liability is limited to repair or replacement of products found to be defective, and specifically excludes liability for incidental or consequential loss or damage.

This product complies with safety specifications and requirements for connecting devices and towing systems of the state of New York, V.E.S.C.Regulation V-5 and SAE J684.