



2,000-Lb. 12 Volt DC Electric ATV Winch

Owner's Manual



⚠ WARNING: Read carefully and understand all ASSEMBLY AND OPERATION INSTRUCTIONS before operating. Failure to follow the safety rules and other basic safety precautions may result in serious personal injury.

Item # ENT4401P

SAVE THESE INSTRUCTIONS



Thank you very much for choosing Enthuze Automotive Products!

For future reference, please complete the owner's record below:

Serial Number/Lot Date Code: _____

Purchase Date: _____

Save the receipt, warranty, and this manual. It is important that you read the entire manual to become familiar with this product before you begin using it.

This electric winch is designed for certain applications only. Enthuze is not responsible for issues arising from modification or improper use of this product such as an application for which it was not designed. We strongly recommend that this product not be modified and/or used for any application other than that for which it was designed.

For technical questions, please contact our customer support.

Enthuze Automotive Products

Email: info@enthuze.ca

Website: www.enthuze.ca

Table of Contents





Intended Use	4
Technical Specifications	4
Important Safety Information	5
Specific Operation Warnings	7
Assembly Instructions	8
Before Each Use	11
Operating Instructions	11
After Each Use	14
Maintenance	15
Troubleshooting	15
Parts List	17
Replacement Parts	18
Limited Warranty	19

Intended Use

The Enthuze 2000-Lb. 12 Volt DC Electric ATV Winch has a permanent magnet motor which draws less current, making it ideal for ATV use. The Differential Planetary gear system allows for fast line speed while the automatic load-holding brake provides maximum safety. It has free spooling for a fast line-out, a roller fairlead with nylon bushings and an aircraft-grade wire rope.

Technical Specifications

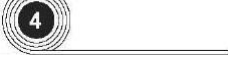
Property	Specification
Rated Single Line Pull	2,000lb (907kg)
Application	Utility/Shop/ATV
Motor	12V DC 1.1 HP Permanent Magnet
Power In & Power Out	Yes
Duty Cycle Rating	5% (45 Seconds at Max Rated Load; 14 minutes, 15 seconds rest)
Wired Remote Controller	Wired, 10ft (3.04m) Long
Gear Train	Differential Planetary
Gear Ratio	153:1
Free Spool	Pull and Turn
Brake	Automatic Load Holding Dynamic
Drum Diameter	1.24" X 2.83" (31.5mm x 72 mm)
Hook	1/4" Clevis, with Spring-Loaded Safety Latch
Fairlead	Roller with Nylon Bushings
Wire Rope Size /Type	5/32" x 50' (4.0mmX15.2m) 7X19 Galvanized Steel Aircraft-Grade Wire Rope
Battery	12V DC Minimum 12Ah
Battery Cables	10 Gauge, 6' (1.83m) long
Motor Cables	10 Gauge, 4' (1.23m) long
Mounting Bolt Pattern	3.15" (80mm)
Mounting Hardware	Winch: 2xG8, M8-1.25X35mm (0.05" X 1.38")
Overload Protection	In-line Circuit Breaker
Sound Rating	85 db
Overall Dimensions (L X D X H)	11.1"x4.6"x4.2" (282mmx117mmx106mm)
Weight	13.2lb (5.98 kg)
IP Rating	IP 65 - Winch and Controls (resistant to water jets)

Layer	Rated Line pull	Rope Length/ Layer
 1	2000lb (907kg)	6' (1.8m)
 2	1636lb (742kg)	13.3' (4.0m)
 3	1384lb (628kg)	21.9' (6.7m)
 4	1200lb (544kg)	31.8' (9.7m)
 5	1058lb (480kg)	43.1' (13.1m)
 6	947lb (430kg)	50' (15.2m)

First Layer of Wire Rope Performance			
 1	Line Pull lb (kg)	Line Speed fpm (m/min)	Amp Draw (DC12V)
	0 (0)	13.3 (4.1)	10
	1000 (454)	8.3 (2.5)	55
	2000 (907)	4.1 (1.2)	106

Important Safety Information

⚠WARNING

- Read and understand all instructions. Failure to follow all instructions may result in fire, serious injury and/or DEATH.
- The warnings, cautions and instructions in this manual cannot cover all possible conditions or situations that could occur. Exercise common sense and caution when using this electric winch. Always be aware of the environment and ensure that the electric winch is used in a safe and responsible manner.
- Do not allow anyone to operate or assemble the electric winch until they have read this manual and have developed a thorough understanding of how it works.
- Do not modify this electric winch in any way. Unauthorized modification may impair the function and/or safety and could affect the life of the electric winch. There are specific applications for which the electric winch was designed.
- Use the right tool for the job. DO NOT attempt to force small equipment to do the work of larger industrial equipment. There are certain applications for which this electric winch was designed. The tool will be safer and do the job better at the capacity for which it was intended. DO NOT use this equipment for a purpose for which it was not intended.
- Industrial or commercial applications must follow OSHA requirements.

⚠️ WARNING

WORK AREA SAFETY

- Inspect the work area before each use. Keep work area clean, dry, free of clutter and well-lit. Cluttered, wet or dark work areas can result in injury. Using the electric winch in confined work areas may put you dangerously close to other cutting tools and rotating parts.
- Keep children and bystanders away from the work area while operating the tool. Do not allow children to handle the electric winch.

⚠️ WARNING

PERSONAL SAFETY

- Stay alert, watch what you are doing and use common sense when operating the electric winch. Do not use the electric winch while you are tired or under the influence of drugs, alcohol or medication. A moment of inattention while operating the tool may result in serious personal injury.
- Dress properly. Do not wear loose clothing, dangling objects or jewelry. Keep your hair, clothing and gloves away from moving parts. Loose clothes, jewelry or long hair can be caught in moving parts. Air vents on the tool often cover moving parts and should be avoided.
- Wear the proper personal protective equipment when necessary. Use ANSI Z87.1 compliant safety goggles (not safety glasses) with side shields, or when needed, a face shield. Use a dust mask in dusty work conditions. Also use non-skid safety shoes, hardhat, gloves, dust collection systems and hearing protection when appropriate. This applies to all persons in the work area.
- Do not overreach. Always keep proper footing and balance.

⚠️ CAUTION

ELECTRIC WINCH USE AND CARE

- Inspect before every use, do not use if damaged or parts loose. Examine the winch for structural cracks, bends, damage, frayed or kinked rope, and any other conditions that may affect the safe operate of the winch. Do not use the winch even if minor damage appears. A kink permanently weakens the rope. Even after it is straightened out, kinked rope can fail suddenly and must not be used.
- Do not force the electric winch. Products are safer and do a better job when used in the manner for which they are designed. Plan your work and use the correct product for the job.
- Store the winch in a dry, secure place out of the reach of children when it is not in use. Inspect the tool for good working condition prior to storage and before re-use.
- Use only accessories that are recommended by the manufacturer for use with your electric winch. Accessories that may be suitable for one product may create a risk of injury when used with another tool. Never use an accessory that has a lower operating speed or operating pressure than the tool itself.

Specific Operation Warnings

⚠ WARNING

GENERAL SAFETY

- To prevent injury or property damage, read and understand all instructions before operating winch.
- Wear ANSI Z87.1 compliant safety goggles and heavy duty leather work gloves during operation.
- Do not exceed the rated load capacity. Be aware of dynamic loading! Sudden load movement may briefly create excess load, causing product failure.

INSTALLATION SAFETY

- Choose a mounting location that can support the winch and rated load capacity.
- Do not weld mounting bolts.
- Use supplied power cords and rope listed in manual only. Do not use thinner/longer cables or link multiple cables together.
- Keep hands clear of winch rope, hook loop, hook and fairlead opening during installation, operation, and when spooling in or out.
- Wrap the rope under 500 lbs. of tension before use. Otherwise, the rope may bind during operation.
- Do not route electrical cables near sharp edges or parts that will move or become hot.
- Work in a well-ventilated area. Explosive hydrogen gas can accumulate and explode when ignited by a spark or open flame.
- Only connect to a clean, corrosion-free battery.
- Remove all jewelry and metallic objects before working near battery.

WINCHING SAFETY

- Inspect winch rope, hook, and slings before operating winch. Frayed, kinked or damaged winch rope must be replaced immediately. Damaged components must be replaced before operation.
- Do not maintain power to the winch if the motor stalls. Verify the load is within the rated capacity for the wire rope layer. Make sure the battery is fully charged. Use double line rigging whenever possible.
- Do not engage or disengage clutch while under load.
- Always ensure hook latch is closed and not supporting load.
- Never apply load to hook tip or latch. Apply load only to the center of hook.
- Never use a hook that has been bent, warped or twisted.
- Keep clear of fairlead when operating. Do not try to guide rope.
- Do not place any fingers through the hook. Fingers may be caught and get pulled into the fairlead or drum. Use the included strap to hold the hook instead.
- Stay out of the direct line that the rope is pulling. If it slips or breaks, it will create a whiplash effect. Utilize a winch dampener to help absorb the force released if the rope breaks.

- Do not use for overhead hoisting. This winch is intended to be used for pulling only.
- Use a spotter to assist you with safe operation of the winch. Make sure the spotter is out of the way of the vehicle and the rope before activating the winch.
- Do not use the hand crank, if equipped, to assist the winch.
- Do not use vehicle to pull on the rope and assist the winch.
- Do not use to transport people or animals.
- Disconnect battery cables before working near the rope, drum, fairlead or load to prevent accidental starting.
- Keep rope straight to avoid kinking the rope.
- Keep children and bystanders away while operating.
- Hook onto the object using a pulling point, tow strap or chain. Do not wrap the rope around the object and hook onto the rope itself.
- Do not use a recovery strap while winching.
- Secure the load after moving. Do not lock the mechanism.
- Keep at least 5 full turns of rope on the drum.
- Keep clear of the rope, hook, and load while winching. Do not step over the rope or apply pressure to the rope under tension. The rope might break and cause personal injury.
- If the rope begins to get entangled, stop the winch immediately and release the rope using the switch.
- Only winch with the winching vehicle's transmission placed in neutral. Winching with a vehicle's transmission in gear or park may damage the transmission. A vehicle's transmission is not designed to handle this type of load.
- Do not operate the winch on extreme slopes. Do not exceed 45° from center line of vehicle for a roller fairlead. For a Hawse fairlead, the angle should be as close to vehicle center line as possible.
- People with pacemakers should consult their physicians before use. Electromagnetic fields near a heart pacemaker could cause pacemaker interference or pacemaker failure.
- Remove all obstacles before operation.
- Always use supplied hook strap whenever spooling winch rope in or out, during installation and during operation.
- Always take time to use appropriate rigging techniques for winch pull.

Assembly Instructions

⚠ WARNING

Read the entire Important Safety Information section at the beginning of this manual, including all text under subheadings, before setting up or using this electric winch.

Mounting the Winch

1. The mounting plate must be rated to at least the winch's capacity.
2. Align the winch perpendicular to the center line of the vehicle at the desired location and mark the locations of the winch base holes. Compare the dimensions of the marked holes.

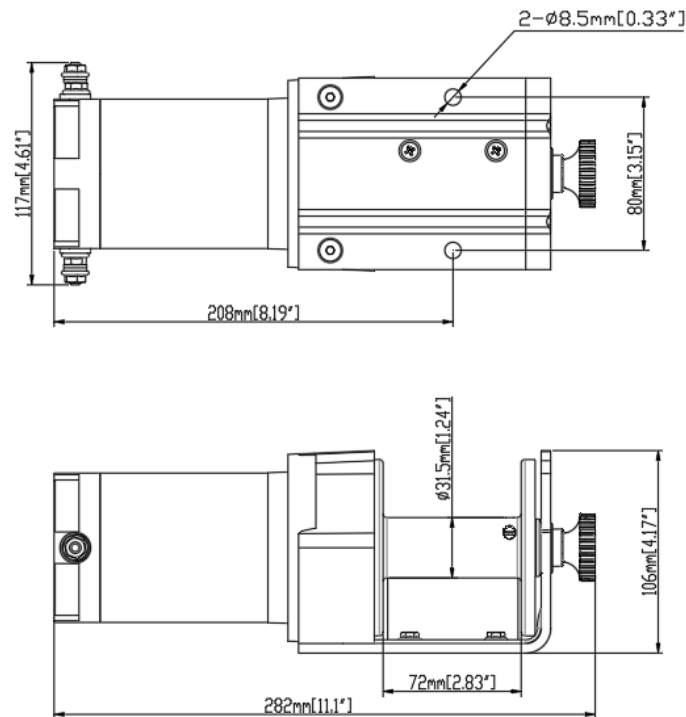

3. Before drilling, verify that the installation surface has no hidden components or structural pieces that will be damaged.

Note: This winch can generate extreme forces. Select a location that can withstand the rated capacity without damage or weakening. Steel reinforcement plates may be needed or a certified welder may need to weld on additional bracing, depending on the mounting location.

4. Drill holes appropriate for the hardware at the marked locations.
5. Install the winch using hardware described under the specifications table.

Mounting the Solenoid Assembly

1. Mount the solenoid box in proper location so that:
 - a) The winch components are close enough to each other to allow wires to be routed properly.
 - b) The vehicle component operation is not interfered with.
 - c) The vehicle components are not damaged by drilling or driving screws.
 - d) The winch components will not be damaged by stresses caused by vehicle operation.
2. Mark the location where the screw holes will be.
3. Verify that the installation surface has no hidden components or structural pieces that will be damaged before drilling.

4. Drill pilot holes for the mounting screws.
5. Secure in place with mounting screws.

Wiring

To prevent serious injury from explosion (sparking at the battery connection), disconnect the battery cables before making other wiring connections.

To prevent serious injury from leaking battery acid, do not use a dirty, corroded or leaking battery. Only use a 12V automotive (or equivalent) battery, in good condition.

1. Plan a route for the wiring from the planned winch location to the battery. This route must be secure and out of the way of moving parts, road debris, or any possibility of being damaged by operation or maintenance of the vehicle. For example, you may wish to route the wires under the vehicle, attaching it to the frame using suitable fasteners. Do not attach the wires to the exhaust system, drive shaft, emergency brake cable, fuel line, or any other components which may damage the wiring through heat or motion, or create a fire hazard.
2. If you drill through the bumper or any part of the body to route the wires, be sure to install a rubber grommet in the hole to prevent fraying the wires.
3. Route the cables from the solenoid to the battery and from the solenoid to the winch, following the precautions discussed above. See the following picture.

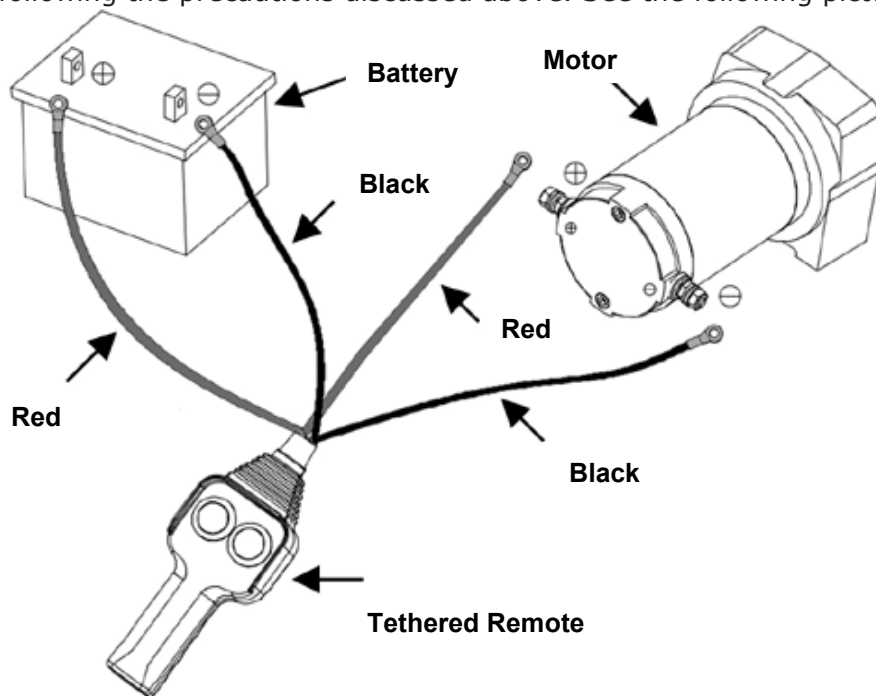

Wiring Connection

4. Attach the short wires from the remote to the terminals on the motor.
5. Attach the red battery cable directly to the positive terminal on the battery.
6. Attach the black battery cable directly to the negative terminal of the battery.

Note: The attachment of the motor cables determines the operation of the remote's button. After the unit is mounted and powered, check the direction of the Power In and Power Out on the remote button. If you wish to change the direction on the remote, disconnect the battery cables from the battery, switch the motor cable connections on the motor assembly, then reconnect the battery cables.

Preparing the Wire Rope

1. The wire rope must be properly coiled under tension to be able to support a load without damage.
2. Uncoil the wire rope, except for 5 full wraps.
3. Recoil the rope back into the winch under at least 500 lb. of tension.

Before Each Use

⚠ WARNING

- Inspect the winch rope, hook, and slings before operating the winch. Frayed, kinked or damaged winch ropes must be replaced immediately. Damaged components must be replaced before operation.
- Wrap the rope under 500 lbs. of tension before use. Otherwise, the rope may bind during operation.
- Work in a well-ventilated area. Explosive hydrogen gas can accumulate and explode when ignited by a spark or open flame.
- Remove all jewelry and metallic objects before working near batteries.

Operating Instructions

⚠ WARNING

- Read the entire Important Safety Information section at the beginning of this manual, including all text under subheadings, before setting up or using this winch.
- The instructions that follow are basic guidelines only and cannot cover all situations encountered during use. The operator and assistants must carefully plan usage to prevent accidents.

Clutch Operation

1. The position of the pin in the shaft determines whether the clutch is engaged or not.

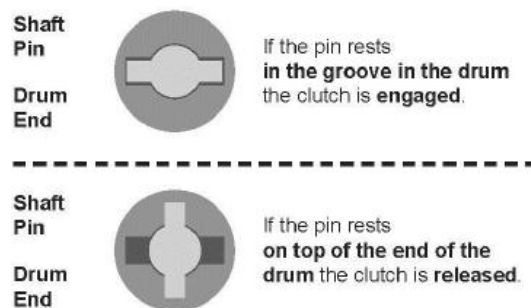

2. To change clutch position:
 - a) Pull clutch knob out
 - b) Turn it 90° while it is pulled out, then release it.

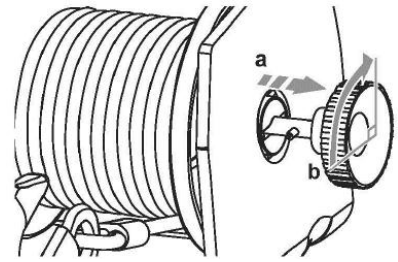

Basic Operation

Note: If a winch is to be used to pull a vehicle, it should optimally be rated to a single line pull at least twice the vehicle's weight.

1. Examine the rope. Do not use the winch if the rope is frayed, kinked, or damaged.
2. Fully charge the vehicle's battery.
3. Check the winch's electrical connections. All connections must be tight and clean.
4. Put the vehicle's transmission in 'neutral'.
5. If the vehicle (where the winch is mounted) is not supposed to be moved, engage the emergency brake and block the wheels using wheel chocks (sold separately).
6. To pull out the rope, move the clutch control to the released position (same as photo in Step 2 on Page 11), slide the loop of the hook strap over the hook, then pull on the hook strap to pull out the rope.

⚠WARNING

Leave at least five full turns of rope on the drum.

7. Hook onto the object using a pulling point, tow strap, tree strap or chain. See the following picture.



Do not wrap the rope around the object and hook onto the rope itself. This can damage the object being pulled, and kink or fray the rope.

8. The attachment point must be centered in loop of the hook and the hook's safety clasp must be fully closed. See the following picture.

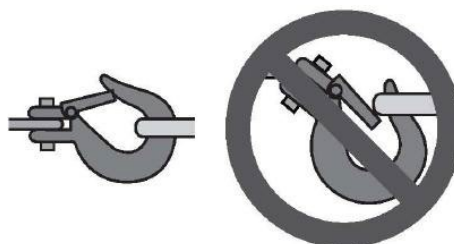

9. Do not use a recovery strap while winching. They are designed to stretch and can suddenly whip back towards the operator during a winching operation.
10. Place a heavy rag or carpet (sold separately) over the rope span, 6 feet from the hook, to help absorb the force released if the rope breaks.

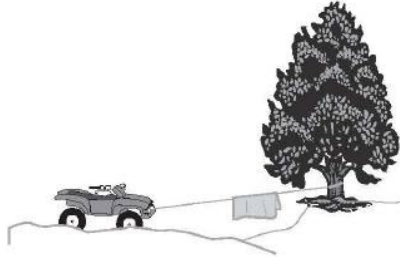

11. Move the clutch control to the engaged position. See the instruction for your winch model under clutch operation.

⚠WARNING

Do not allow anyone to stand near the rope, or in-line with the rope behind the winch while it is under power. If the rope should slip or break, it can suddenly whip back towards the winch, causing a hazard for anyone in the area. Stand to the side while winching.

12. Operate the wired remote controller briefly to ensure the controls work properly. If operation is reversed, the power cables may be connected backwards. Correct any such issue before use.
13. When it is safe to do so, use the power switch on the wired remote controller to retract the rope, and winch the item as desired. To prevent damage, do not power the hook all the way into the fairlead.
14. Do not operate the winch at extreme angles. Do not exceed the angles shown below for a roller fairlead. For a Hawse fairlead, the angle should be as close to straight as possible.

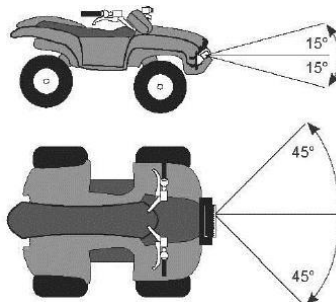

15. If the object to be pulled must be pulled at an angle in relation to the winch, use a pulley (sold separately) and an anchor point directly in front of the winch (see illustration) to keep the rope pulled straight.

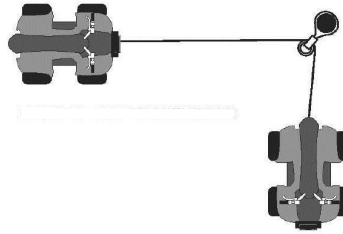

⚠ WARNING

Stop the winch and release tension on the rope before moving the rag or carpet placed on it.

16. Do not continue use of the winch until the battery is completely run down. Stop before it reaches that point.
17. When possible, keep the engine running while using this winch to continually recharge the battery and prevent the battery from being drained so much that the vehicle cannot start. However, you should use extreme caution when working around a running vehicle and ONLY operate a vehicle in an outdoor area.

Note: Do not use the winch in a constant duty application; it is designed for INTERMITTENT USE ONLY. Keep the duration of the pulling job as short as possible. If the motor becomes very hot to touch, stop and let it cool down for several minutes. Do not pull for more than one minute at or near the rated load. Do not maintain power to the winch if the motor stalls. Double-line rigging will help prevent overloading and should be used whenever practical.

18. When finished pulling the load, reverse the direction of the winch just enough to release tension on the rope so that you can unfasten the hook from the load and reel in the rope.
19. Disconnect the wired remote controller (if equipped) after use.

Duty Cycle (Duration of Use)

Avoid damage to the winch by not winching for more than the prescribed duty cycle time.

The duty cycle defines the amount of time, within a 15-minute period, during which a winch can operate at its maximum capacity without overheating. For example, this winch with a 5% duty cycle at its maximum load must be allowed to rest for at least 14 minutes, 15 seconds after every 45 seconds of continuous operation. Failure to carefully observe duty cycle limitations can easily over-stress a winch and contribute to premature winch failure.

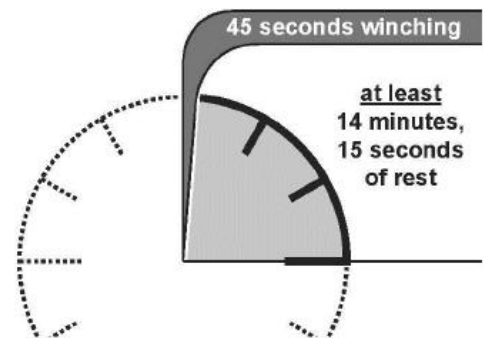

After Each Use

⚠ WARNING

Wipe external surfaces of the winch with a clean cloth.

Maintenance

⚠ WARNING

- To prevent serious injury from accidental operation, disconnect the battery cables before performing any inspection, maintenance or cleaning procedures
- To prevent serious injury from winch failure, do not use damaged equipment. If an abnormal noise or vibration occurs, have the problem corrected before further use.
- Lubricate the wire rope occasionally with a light oil.
- The winch's internal mechanism is permanently lubricated. Do not open the housing. However, if the winch is submerged, it should be opened, dried, and re-lubricated by a qualified technician as soon as possible to prevent corrosion.

Troubleshooting

⚠ WARNING

- Follow all safety precautions whenever diagnosing or servicing the tool.
- Disconnect power supply before service.

Use the table below to troubleshoot problems before contacting service personnel. If the problem continues after troubleshooting, contact us at info@enthuze.ca for assistance.

Failure	Possible Cause	Corrective Action
Motor overheats	<ol style="list-style-type: none"> 1. Incorrect power cords 2. Winch is running too long 	<ol style="list-style-type: none"> 1. Use only supplied power cords 2. Allow winch to cool down periodically
Motor does not turn on	<ol style="list-style-type: none"> 1. Remote battery is dead 2. Loose battery cable connections 3. Vehicle battery needs charging 4. Solenoid is malfunctioning 5. Remote damaged. 6. Defective motor 7. Water has entered motor 8. Internal damage or wear 	<ol style="list-style-type: none"> 1. Replace remote battery 2. Tighten nuts on all cable connections 3. Fully charge battery 4. Tap solenoid to loosen contacts. Apply 12 volts to coil terminals directly. A clicking indicates proper activation 5. Replace remote 6. Check for voltage at armature port with switch pressed. If voltage is present, replace motor 7. Allow to drain and dry. Run in short bursts without load until completely dry 8. Have technician service winch
Motor runs but rope	Clutch not engaged	Move the clutch handle to the engaged position. If problem persists, a qualified technician needs to check and repair.

drum does not turn		
Motor runs slowly or without normal power	<ol style="list-style-type: none"> 1. Insufficient current or voltage 2. Loose or corroded battery cable connections 3. Incorrect power cords 	<ol style="list-style-type: none"> 1. Battery weak, recharge it. Run winch with vehicle motor running 2. Clean, tighten, or replace 3. Use only supplied power cords
Motor runs in one direction only	<ol style="list-style-type: none"> 1. Defective or stuck solenoid 2. Remote damaged 	<ol style="list-style-type: none"> 1. Tap solenoid to loosen contacts Repair or replace solenoid 2. Replace remote

Parts Diagram

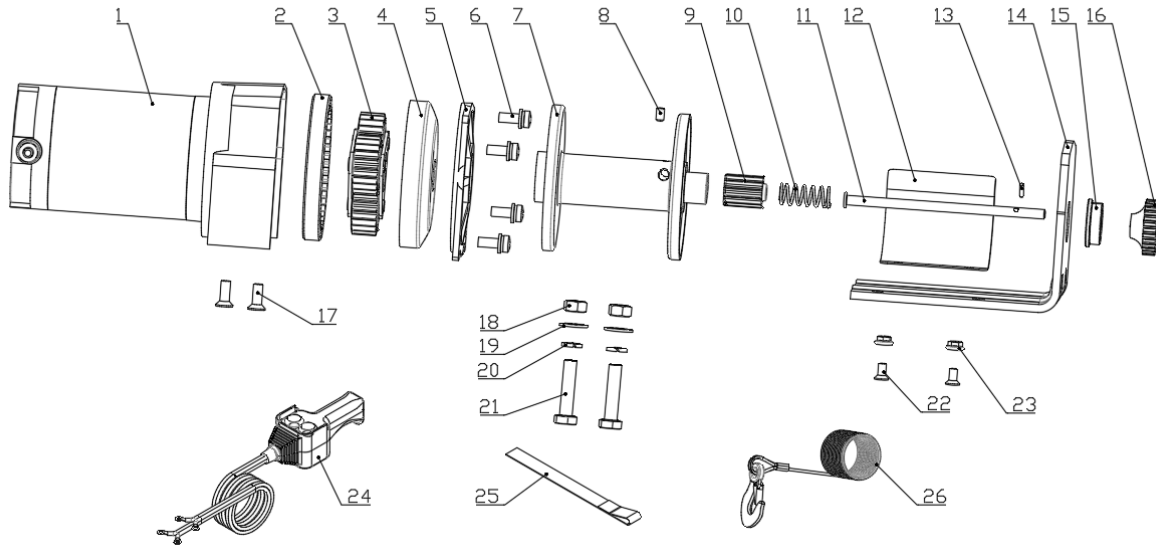

Parts List

Part Number	Description	Quantity
1	Motor	1
2	Gear Ring	1
3	Planetary Gear Assembly	1
4	Rotator Gear	1
5	Drum Support Plate	1
6	Pan Head Screw M6x16	4
7	Drum Assembly	1
8	Screw M5x8	1
9	Spline	1
10	Spring	1
11	Clutch Assembly	1
12	Tension Plate	1
13	Pin 2.5 x 12	1
14	Baseplate	1
15	Bushing	1
16	Clutch Knob	1
17	Hex Socket Screw M6x 16	2

Part Number	Description	Quantity
18	Nut M8	2
19	Flat gasket M8	2
20	Spring washer M8	2
21	Hexagon bolt M8 x 35	2
22	Screw M5 x 12	2
23	Hex Flange Nut M5	2
24	Wired Remote Controller	1
25	Red Strap	1
26	Cable Assembly	1

Replacement Parts

- For replacement parts and technical questions, please call Customer Service at **info@enthuze.ca**
- Not all product components are available for replacement. The illustrations provided are a convenient reference to the location and position of parts in the assembly sequence.
- When ordering parts, the following information will be required: item description, item model number, item serial number/item lot date code, and the replacement part number.
- The distributor reserves the rights to make design changes and improvements to product lines and manuals without notice.

Limited Warranty

Enthuze Automotive Products ("Us" or "We") warrants to the original purchaser only ("You" or "Your") that the Enthuze product purchased will be free from material defects in both materials and workmanship, normal wear and tear excepted, for a period of one year from date of purchase. The foregoing warranty is valid only if the installation and use of the product is strictly in accordance with product instructions. There are no other warranties, express or implied, including the warranty of merchantability or fitness for a particular purpose. If the product does not comply with this limited warranty, Your sole and exclusive remedy is that We will, at our sole option and within a commercially reasonable time, either replace the product or product component without charge to You or refund the purchase price (less shipping). This limited warranty is not transferable.

Limitations on the Warranty

This limited warranty does not cover: (a) normal wear and tear; (b) damage through abuse, neglect, misuse, or as a result of any accident or in any other manner; (c) damage from misapplication, overloading, or improper installation; (d) improper maintenance and repair; and (e) product alteration in any manner by anyone other than Us, with the sole exception of alterations made pursuant to product instructions and in a workmanlike manner.

Obligations of Purchaser

You must retain Your product purchase receipt to verify date of purchase and that You are the original purchaser. To make a warranty claim, contact **info@enthuze.ca**, identify the product by make and model number, and follow the claim instructions that will be provided. The product and the purchase receipt must be provided to Us in order to process Your warranty claim. Any returned product that is replaced or refunded by Us becomes our property. You will be responsible for return shipping costs or costs related to Your return visit to a retail store.

Remedy Limits

Product replacement or a refund of the purchase price is Your sole remedy under this limited warranty or any other warranty related to the product. We shall not be liable for: service or labor charges or damage to Your property incurred in removing or replacing the product; any damages, including, without limitation, damages to tangible personal property or personal injury, related to Your improper use, installation, or maintenance of the product or product component; or any indirect, incidental or consequential damages of any kind for any reason.

Assumption of Risk

You acknowledge and agree that any use of the product for any purpose other than the specified use(s) stated in the product instructions is at Your own risk.



Enthuze Automotive Products

www.enthuze.ca

info@enthuze.ca